

Product # _____ Type _____ Date _____

Project Name _____

Project Location _____ Prepared By _____

Smart™ Area 150/200

Smart™ Light Specifications

The 150/200 watt Smart™ Area is designed to replace HID light sources of up to 400 watts. This is accomplished with sealed high brightness light modules with precision control TIR type optics.

Construction

Housing is die-formed made from low-copper 5052 aluminum, heavy duty, structurally rigid and vibration resistant. Heatsink fins are 0.040" thick made from low copper aluminum 5052 alloy with maximum contact with the housing for maximum heat dissipating surface area for the efficient cooler operation. Five available mounting options. Suitable for Wet Locations.

Optics/Lens

Smart™ Area contains 2 x 75 or 2 x 100 watt IP67 sealed light modules and are field replaceable. LED Modules are available in TypeII, TypeIII and TypeV distribution patterns.

Electrical

High power LED source, with performance of greater than 100lpw (lumens per watt). Available in range of Color Temperature 2700K-5000K, CRI of 70 or greater. LED Drivers: UL/CSA recognized component to meet UL8750 & EN61347 (USR/CNR - E328335). Suitable for input power at 100-277VAC, Minimum power factor >0.95 with an operating temperature range of -22-140 degrees F / -30C to +55C. Dimmable and motion sensor control compatible.

Finish

Dark Bronze finish. Other optional colors available on request.

Warranty and Certifications

5 year limited warranty for LED Light Engine and Driver, 7 years for housing. 50,000 hours @ 25°C L70 LED Illumination per LM-80. cULus Wet Locations in compliance with UL 1598 and CSA C22.2 NO. 250.0 standards. IP65, IP67 upgrade option. Suitable for indoor/outdoor wet or damp location use. DLC listed and Lighting Facts.



Adjustable Trunnion Shown

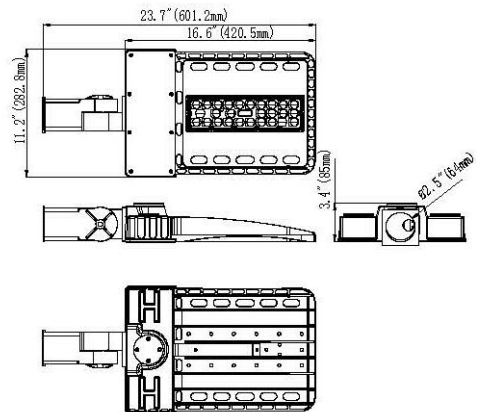

Fixture EPA: 1.0 sq. ft.

Weight: 28 lbs.



Ordering Guide

MODEL	TOTAL LED POWER	CCT COLOR TEMP	LIGHT BEAM SPREAD	INPUT VAC	LIGHTING CONTROL	GLARE CONTROL	MOUNTING TYPE
SMA-V	150 = 150W 200 = 200W	50 – 5000K (standard) 40 – 4000K 30 – 3000K 27 – 2700K	2 = Type II 3 = Type III 5 = Type V	U = Universal 100V to 277V 34 = 347V 48 = 480V	D = Dimming ND = Non Dimming PC = Photo Control	**Consult factory for available options	4 - adjustable knuckle/slipfitter 6 - arm mount 7 - wall mount RP - Round Pole Adapter TR - Adjustable Trunnion

Note: Due to continued efforts to improve our products, specifications are subject to change without notice.



835 Industrial Drive, Elmhurst, IL 60126 708.681.4330 www.nslights.com

Smart™ Area 150/200

Photometrics

150W

TYPE II LENS

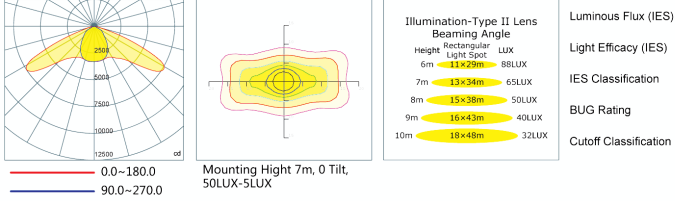

200W

TYPE III LENS

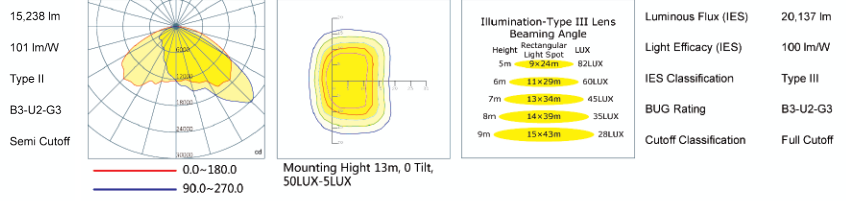

TYPE III LENS

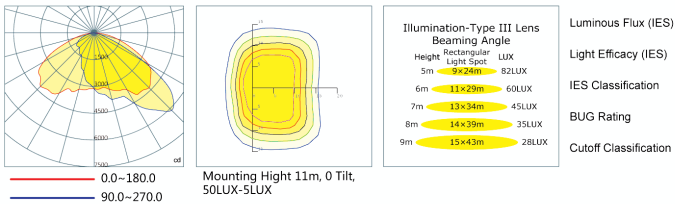

TYPE II LENS

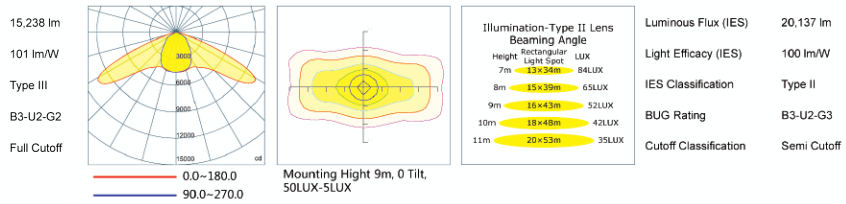

TYPE V LENS

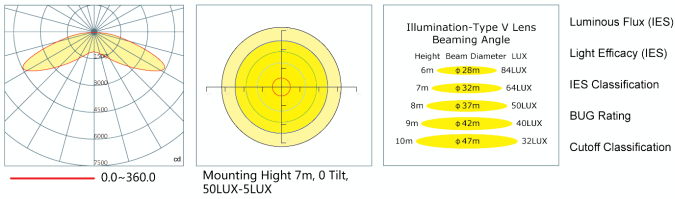

TYPE V LENS

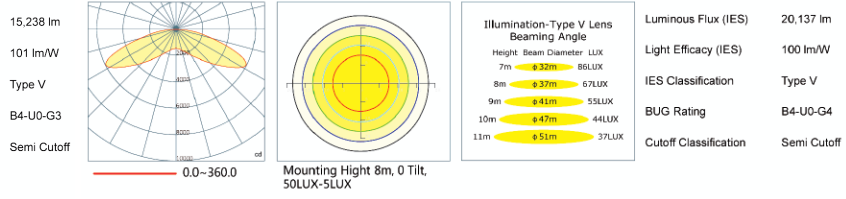

Round Pole Adapter

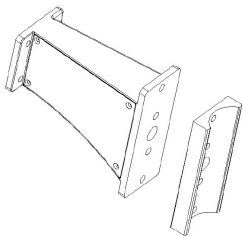

Trunnion Mount



Photocell

