

THORN



Legend



North Star Lighting



A new concept in city lighting, combining high streetlighting performance values within an attractive and decorative amenity lantern



Legend is a new range of amenity lanterns for city lighting applications, where a new concept is adopted for amenity lanterns, based on high performance reflectors, giving no direct upward light, integrated into attractive and decorative lanterns.

This new range from Thorn recognises the growing demand for low light pollution lanterns for city lighting. In addition the materials used in the lantern construction are environmentally friendly.

Two different shapes are available:

- A modern shape, mainly dedicated to modern city centres and residential areas.
- A classic shape, for application in older towns and historical areas.

Due to the high performance of the optics, this new range can be used not only for amenity lighting, but also for some street lighting applications such as residential, pedestrian, and inner city streets.



Urban Planning approach

Through the ages, cities have grown in size. Their buildings and transport systems reflect this evolution in their architectural styles and locations.

Typical city zones



This development can be roughly summarised:

- City centre: the architecture style can cover several centuries from the middle ages to modern day.
- Expansion following the growth generated by the industrial revolution (18th & 19th Century) surrounding the core of the city. It is quite common in this zone for there to be a mixture of architectural styles from for example Victorian through to modern styles.
- Later city expansion: a combination of residential areas, industrial estates, and shopping centres surrounds the other two zones. Here the architectural style is contemporary, even high tech in some cases.

Urban lighting can both create an attractive nightscape and make places safer in which to work and live. The task for the lighting designer can be to keep a visual consistency through the various urban zones to give an integrated identity to the city. Since lighting equipment is becoming more and more part of the city scene a versatile range of products with a consistent style is warranted. Legend provides a solution.

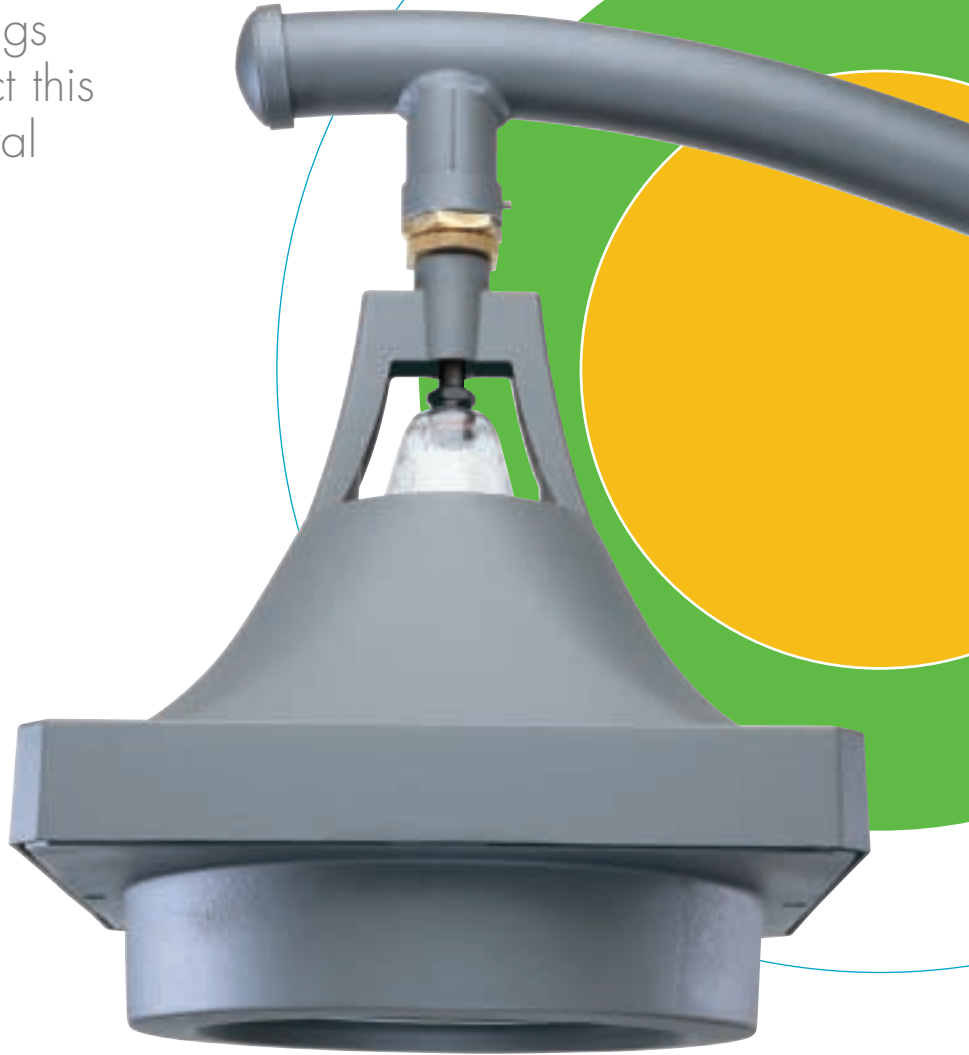

Legend, The lighting solution

The new concept developed by Thorn is based on this urban planning approach. The range offers:

- Two lantern designs **classic** and **modern**, to match the various architectural styles
- Either post top mounting or suspended mounting to match all installation requirements
- An elegant design to ensure a smooth transition between the various urban zones
- A strong, durable, high quality product
- A high performance optical system to provide a light distribution suitable for streetlighting
- A precise light distribution to ensure no direct upward light output, and a consequent reduction in light pollution
- Various light distributions to suit every type of city and urban installation
- The Optibloc® internal optic can be rotated in 45° steps to maintain uniform visual appearance, and to offer flexibility of different distributions.

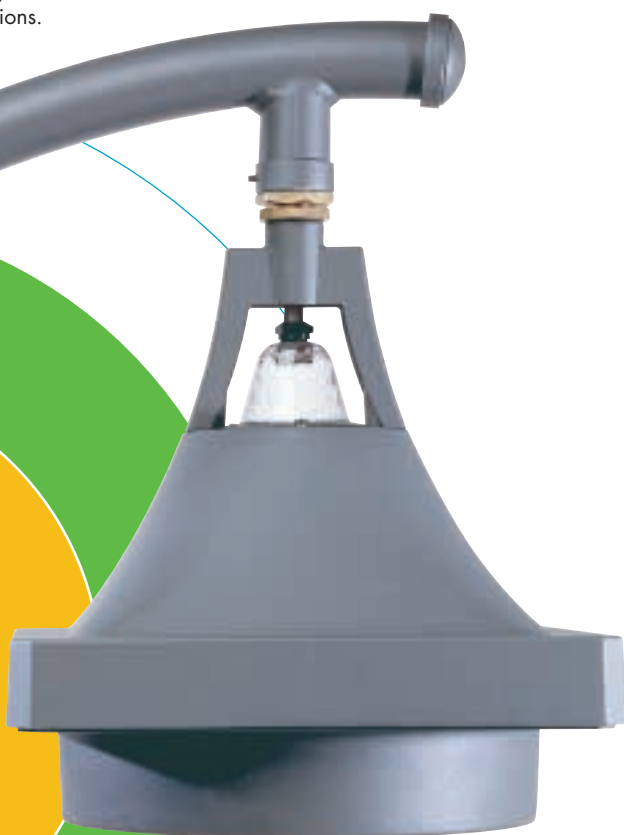
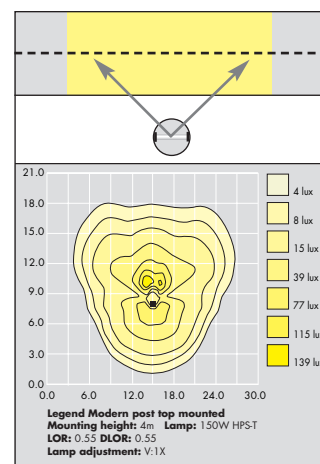
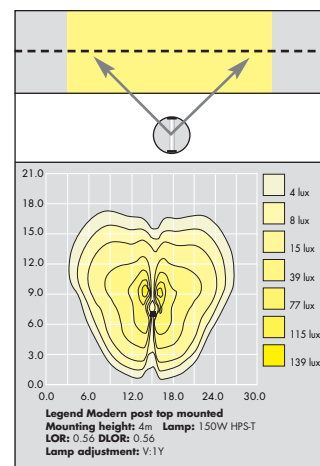



Legend, not only an efficient city lantern, but also an attractive package with dedicated columns and brackets



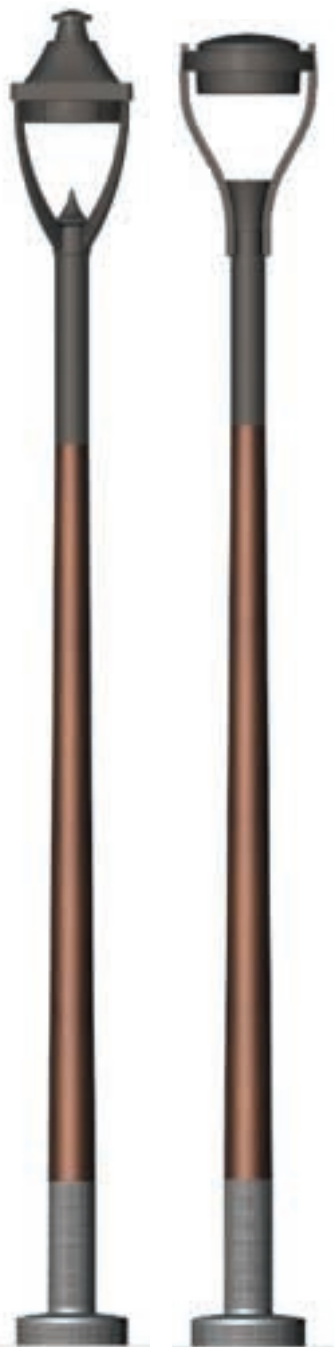
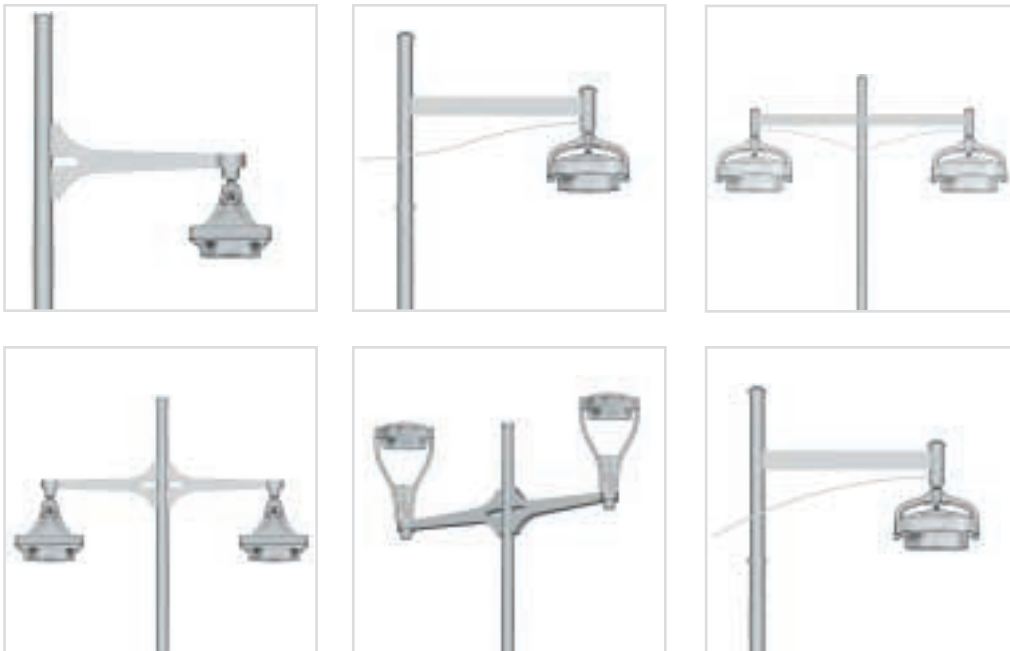

As street design demands a more harmonised approach, Legend offers a dedicated range of columns and brackets.

The innovative shapes of both modern and classic versions of Legend provide design solutions for all architectural styles.

In order to offer a "best value" solution the dedicated range of Legend brackets can be mounted on standard columns, with top diameters of 60 or 76 mm. These brackets are available with the complete range of Legend lanterns (modern, classic, post top or suspended), and can be delivered on request finished in any RAL colour.

First class design is achieved by the association of wood and cast aluminium used in the dedicated Legend column, suitable for both Classic and Modern versions.

Legend Classic

A classic shape, for application in older cities, towns and historical areas



Legend Classic post top and suspended offers the option of an illuminated top cap, for areas where a stronger decorative element is required.

The post top version, inspired by the old gas lanterns comes alive when lit at night by producing a virtual glow effect.



Lamps

- 70, 100, 150W HPS-T
High pressure sodium,
cap: E27 and E40
- 70, 150W CDM-TT
Ceramic metal halide,
cap: E27 and E40
- 80, 125W MBF High
pressure mercury, cap: E27
- 42W TC-TEL Compact
fluorescent, cap: GX24q-4

Materials/Finish

Body: die cast aluminium, dark grey powder coated finish, (close to RAL 9007)
Flat glass enclosure: toughened glass
Reflector: pure aluminium

Installation/Mounting

Post top mounted version on poles 76mm diameter, fixing on shaft through 3 M8 stainless steel screws (supplied)
Suspended version fixed through a 1 inch BSP diameter threaded tube
Recommended mounting height: 4 to 5m



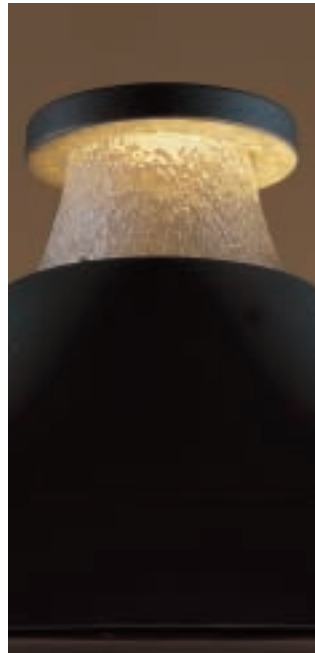

Illuminated top cap

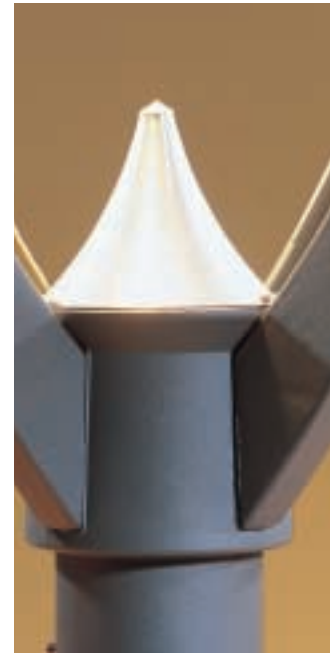

Virtual glow effect

Standards

Designed and manufactured to comply with EN 60598
ENEC certification in progress
Electrical class I
⚡⚡⚡IP65 CE
IK 08 (5 joules) shock resistant

Specification

To specify state:
Post-top or suspended lantern in die-cast aluminium painted in dark grey finish, IK 08 flat toughened glass, with aluminium reflector embodied in an IP65 compartment. Reflector will provide a light distribution for streetlighting, and will have an upward light output ratio of zero. As Thorn Legend Classic.

For ordering guides and data see page 12







Legend Modern

A modern shape, mainly dedicated to modern city centres and residential areas



Lamps

-  70, 100, 150W HPS-T
High pressure sodium, cap: E27 and E40
-  70, 150W CDM-TT
Ceramic metal halide, cap: E27 and E40
-  80, 125W MBF High
pressure mercury, cap: E27
-  42W TC-TEL Compact
fluorescent, cap: GX24q-4

Materials/Finish

Body: die cast aluminium, dark grey powder coated finish, (close to RAL 9007)
Flat glass enclosure: toughened glass
Reflector: pure aluminium

Installation/Mounting

Post top mounted version on poles 76mm diameter, fixing on shaft through 3 M8 stainless steel screws (supplied)
Suspended version fixed through a 1 inch BSP diameter threaded tube
Recommended mounting height: 4 to 5m



Standards

Designed and manufactured to comply with EN 60598
ENEC certification in progress
Electrical class I
⚡⚡⚡ IP65 CE
IK 08 (5 joules) shock resistant

Specification

To specify state:
Post-top or suspended lantern in dies-cast aluminium painted in dark grey finish, IK 08 flat toughened glass, with aluminium reflector embodied in an IP65 compartment.
Reflector will provide a light distribution for streetlighting, and will have an upward light output ratio of zero.
As Thorn Legend Modern.

For ordering guides and data see page 13



Ordering Guides

Dimensions

Data

Legend Classic

Order both lantern and gear tray, and if necessary the post top adaptor. Lamp to be ordered separately. Remote gear trays available on request.

Lantern

Description	Weight (Kg)	UK Product Code	UK Cat. No.
Legend Classic post top version	12.1	7022094	LEGCLP
Legend Classic suspended version	9.9	9022095	LEGCLS

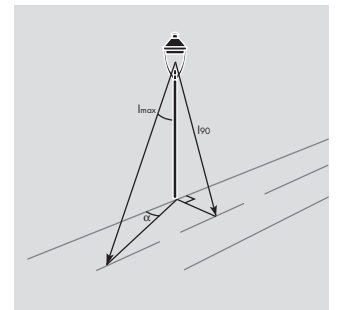
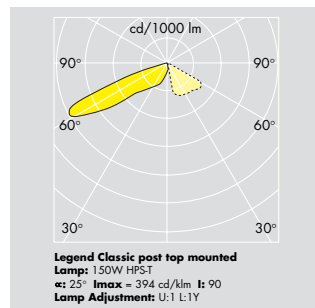
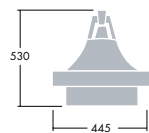
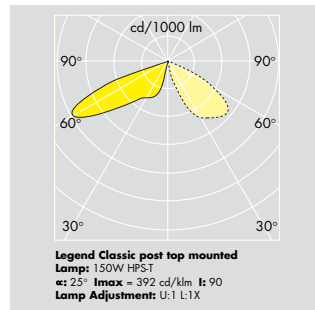
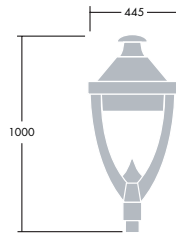

Gear trays

Lamp Type & Rating	Description	Weight (Kg)	UK Product Code	UK Cat. No.
Non illuminated top cap				
70W HPS-T/CDM-TT	Gear tray	2.5	5022098	LEGGT70HPSCDMTT.4
100W HPS-T	Gear tray	2.8	7022099	LEGGT100HPS.4
150W HPS-T/CDM-TT	Gear tray	3.5	6022100	LEGGT150HPSCDMTT.4
80W MBF	Gear tray	2.1	0022102	LEGGT80MBF.4
125W MBF	Gear tray	2.5	2022103	LEGGT125MBF.4
42W TC-TEL	Gear tray	1.3	4022104	LEGGT42CFL.4
	Empty gear tray for E27 lampholder	1.1	6022105	LEGGTE27
	Empty gear tray for E40 lampholder	1.1	8022106	LEGGTE40
Illuminated top cap				
70W HPS-T/CDM-TT	Gear tray	2.4	0022107	LEGTGT70HPSCDMTT.4
100W HPS-T	Gear tray	2.8	2022108	LEGTGT100HPS.4
150W HPS-T/CDM-TT	Gear tray	3.4	4022109	LEGTGT150HPSCDMTT.4
80W MBF	Gear tray	2.0	9022110	LEGTGT80MBF.4
125W MBF	Gear tray	2.5	1022111	LEGTGT125MBF.4
42W TC-TEL	Gear tray	1.3	3022112	LEGTGT42CFL.4
	Empty gear tray for E27 lampholder	1.1	5022113	LEGTGTE27
	Empty gear tray for E40 lampholder	1.1	7022114	LEGTGTE40

For post top adaptor, see accessory ordering guide on page 13

Legend Modern

Order both lantern and gear tray, and if necessary the post top adaptor. Lamp to be ordered separately. Remote gear trays available on request.

Lantern

Description	Weight (Kg)	UK Product Code	UK Cat. No.
Legend Modern post top version	11.4	1022096	LEGMODP
Legend Modern suspended version	9.5	3022097	LEGMODS

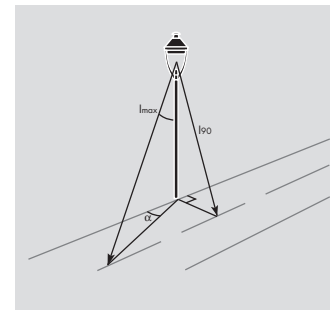
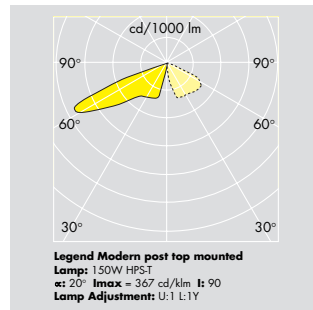
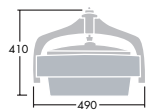
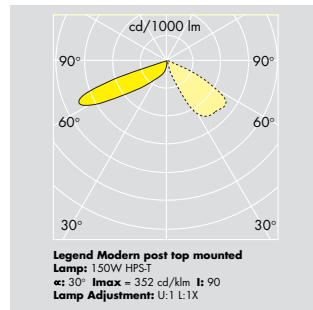
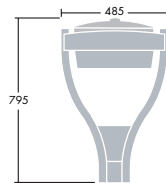

Gear trays

Lamp Type & Rating	Description	Weight (Kg)	UK Product Code	UK Cat. No.
70W HPS-T/CDM-TT	Gear tray	2.5	5022098	LEGGT70HPSCDMTT.4
100W HPS-T	Gear tray	2.8	7022099	LEGGT100HPS.4
150W HPS-T/CDM-TT	Gear tray	3.5	6022100	LEGGT150HPSCDMTT.4
80W MBF	Gear tray	2.1	0022102	LEGGT80MBF.4
125W MBF	Gear tray	2.5	2022103	LEGGT125MBF.4
42W TC-TEL	Gear tray	1.3	4022104	LEGGT42CFL.4
	Empty gear tray for E27 lampholder	1.1	6022105	LEGGTE27
	Empty gear tray for E40 lampholder	1.1	8022106	LEGGTE40

Accessory

Description	Weight (Kg)	UK Product Code	UK Cat. No.
Post top adaptor for 60mm shaft	0.5	8022101	LEGPT60

Technical Information

1 Optibloc® technology
 & The Optibloc® is a well proven
2 Thorn optic design used in
 Riviera, A2000 and Decostreet lanterns, that is now adopted for Legend's optic. It provides a wide choice of light distributions (more than 350) by combining the unique complex curved reflector with both vertical and horizontal lampholder adjustment.

3 High level of safety during & installation and
4 maintenance using TASC®

The best way to ensure the highest safety during installation and maintenance is to ensure there is no mains supply in the lantern when a worker is installing or maintaining the lantern. To achieve this Thorn has developed a patented connector that automatically switches off the mains when the lantern is open for installation or maintenance. This connector is called TASC® for Thorn Automatic Safety Connector.

5 Easy electrical connection & to integral gear tray

6 To avoid lots of tasks needing to be done during installation Legend lanterns are delivered pre-wired, this reduces the risk of mistakes and failure. The electrical connection to the gear tray is by a plug and socket connector that connects or disconnects by hand, no tools are required.

7. Quick installation

The post top mounted version has a single connector situated in the bottom of the post top allowing the installer to make a quick and safe connection to the mains supply. The suspended version of Legend can be delivered on request with a length of cable to ensure a fast and safe connection with the mains supply in the column.

8. Quick maintenance

Quicker repair operations can lower maintenance costs during maintenance. To ensure easy access to the optic, the reflector is not sealed, or screwed in, but only clipped in. By just pushing two clips, the operator has immediate access to the optic. Changing an old lamp, or even replace a broken enclosure takes only a few moments with Legend.

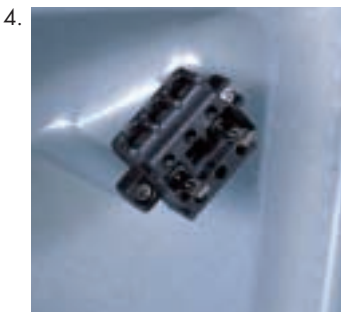



THORN

North Star Lighting, Inc.

Lighting people and places

2150 Parkes Drive Broadview, IL 60155
Tel: 800-229-4330 Fax: 708-681-4006
website: www.nslights.com

Thorn Lighting Limited

UK Sales desk -

Orders/Stock Enquiries

Tel: 08701 610 610
Fax: 08701 610 611

Regional Offices

& Lighting Design Centres

Tel: 08701 610 710
Fax: 08701 610 711

South East - North of London (north)

South East - South of London (south)

Major Projects - Southern (centls)

3 King George Close, Eastern Avenue West,
Romford, Essex RM7 7PP

Midlands (mids)

11 Galena Close, Tamworth,
Staffordshire B77 4AS

South West (southw)

Major Projects - Western (bbcs)

16 Columbus Walk, Atlantic Wharf,
Cardiff, Wales CF10 4TL

Major Projects - Northern (yorks)

Unit 5, Clarke Hall Farm, Aberford Road,
Wakefield, West Yorkshire WF1 4AL

North East (northe)

Trading Estate, Spennymoor,
Co. Durham DL16 7UR

North West (northw)

The Towers, Wilmslow Road, Didsbury,
Manchester M20 2SE

Scotland (scot)

Hamilton Business Centre, Caird Park,
Hamilton, Lanarkshire ML3 0QB

Northern Ireland (northi)

Prince Regent Road, Castlereagh,
Belfast BT5 6QR

e-mail

Each Region has 5 e-mail addresses that are
in a standard format as follows:

(Using 'South West' as an example with its
short code 'southw')

quotes.southw@thornlight.com
orders.southw@thornlight.com
stock.southw@thornlight.com
queries.southw@thornlight.com
enquiries.southw@thornlight.com

Outdoor Lighting

The Towers, Wilmslow Road, Didsbury,
Manchester M20 2SE

Tel: 0161 445 2719

Fax: 0161 448 8015

e-mail: outdoor@thornlight.com

Airfield Lighting

3 King George Close, Eastern Avenue West,
Romford, Essex RM7 7PP

Tel: 01708 776289

Fax: 01708 742322

e-mail: airfield@thornlight.com

Website: www.thornairfield.com

International Sales

3 King George Close, Eastern Avenue West,
Romford, Essex RM7 7PP

Tel: 01708 776284

Fax: 01708 741827

e-mail: international.sales@thornlight.com

Spare Parts

Tel: 0191 301 3131

Fax: 0191 301 3038

e-mail: spares@thornlight.com

Technical Support

Tel: 0870 600 8111

Fax: 0191 301 3907

e-mail: technical@thornlight.com

Brochureline Answering Service

Brochures on specific products/ranges

Tel: 01708 776333

Fax: 01708 776381

e-mail: brochures@thornlight.com

Other Offices in:

Australia, Austria, China, Czech Republic,
Denmark, Estonia, Finland, France, Germany,
Hong Kong, Hungary, India, Ireland, Italy,
Latvia, Lithuania, New Zealand, Norway,
Poland, Russia, Singapore and Sweden

www.thornlighting.co.uk



Member of The Lighting
Industry Federation



UK Sales and
Distribution



FM 12233
UK Manufacturing

Thorn Lighting is constantly developing and improving its products. All descriptions, illustrations, drawings and specifications in this publication present only general particulars and shall not form part of any contract. The right is reserved to change specifications without prior notification or public announcement. All goods supplied by the company are supplied subject to the company's General Conditions of Sale, a copy of which is available on request. All measurements are in millimetres and weights in kilograms unless otherwise stated.

Publication No: 218(UK) Printed in England - 8/02