

Product # _____ Type _____ Date _____

Project Name _____

Project Location _____ Prepared By _____

IWL LED Highbay

The IWL LED High Bay has been engineered to efficiently light any large interior space such as warehouses and heavy industrial settings, gymnasiums, churches, swimming pools/natoriums and shopping malls. It's low profile and light weight design easily adapts to any environ with multiple mounting configurations. IWL provides specification grade optical performance using high efficacy LED and high power factor LED drivers.

Housing

- Low copper, corrosion resistant, die cast aluminum construction.
- One-piece silicone gasket ensures water-tight and dust-tight construction. All external hardware is 316 Stainless Steel.

Optics/Lens

- Optical chamber contains high transmittance clear tempered glass lens sealed (IP65) with silicone gasket. Ultra high efficiency optics provide narrow, medium and wide distribution types.
- Optically clear plastic lens available as factory installed option for food service or food processing applications or as specified. Accessory wireguard is available (IWL-WG) for added protection.

Electrical

- High power LED source, with performance of up to 135 lumens per watt. Available in range of color temperatures 3000K-5000K, CRI of 70 or greater. 2700K available on request. CRI >80 available on request.

LED Drivers

- UL/CSA recognized component to meet UL8750 & EN61347 (USR/CNR -E328335). Suitable for input power at 120-277VAC. Minimum power factor >0.95. Integrated 10kV/5kA surge protection device. Operating Temp. -40°F to +132°F (-40°C to +55°C)
- Available Dimming options include: PWM, 0-10V and Resistance dimming as well as DALI control or Microwave sensor.

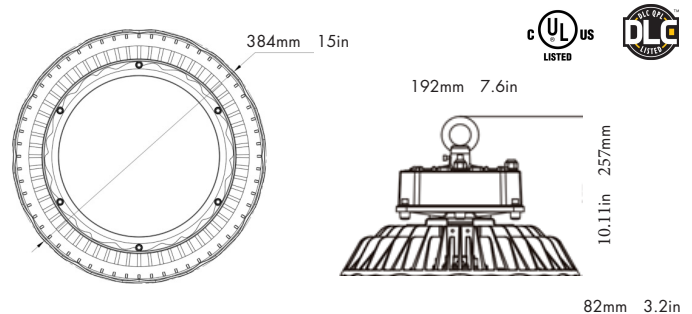

Finish

- Standard finish is high gloss black powder coat heat-radiative coating, anti-corrosion, anti-UV paint. Rated to 55C ambient.

Warranty and Certifications

- 5 years for LED Light Engine and Driver 50,000 hour L70 LED Illumination per LM-80 standards. UL listed in compliance with UL 1598 and CSA C22.2 NO. 250.0 standards. Suitable for indoor/outdoor wet (IP65) or damp location use. DLC approved.

Ordering Guide

MODEL	TOTAL LED POWER	CCT COLOR TEMP	LIGHT BEAM SPREAD	INPUT VAC	LIGHTING CONTROL	MOUNTING
IWL	300	CW	60	U	ND	CM
IWL	300 = 300W 40,500 lumens	CW = 5000K NW = 4000K WW = 3000K	60 = 60° narrow beam 90 = 90° medium beam 120 = 120° wide beam	U = Universal 110V to 277V 347V to 480V	ND = Non Dimming, standard DM = Dimming 1-10V, Interface only. DL = DALI dimming interface MS = Motion sensor	CM = Ceiling mount HK = Hanging hook SM = Stem mount

Note: Due to continued efforts to improve our products, specifications are subject to change without notice.



LED Highbay

Available Light Distribution

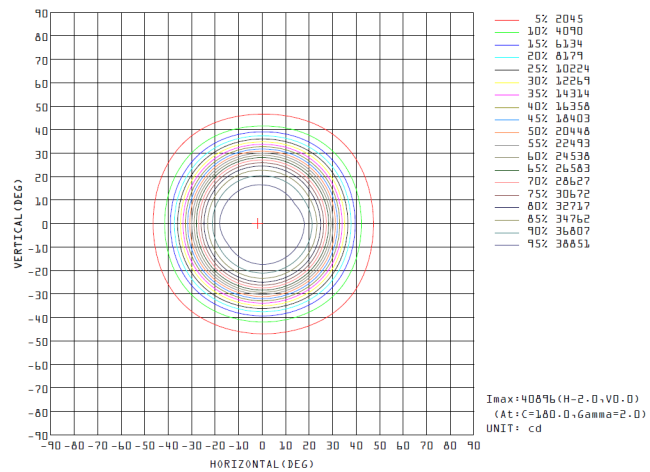
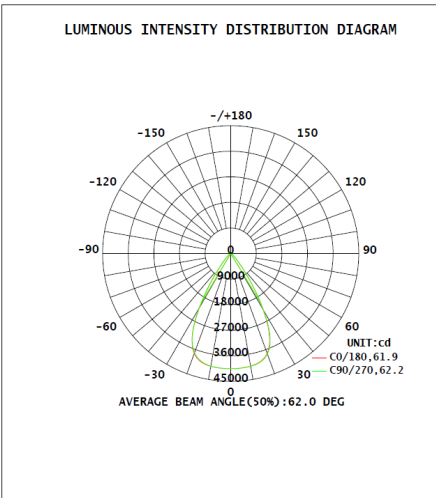
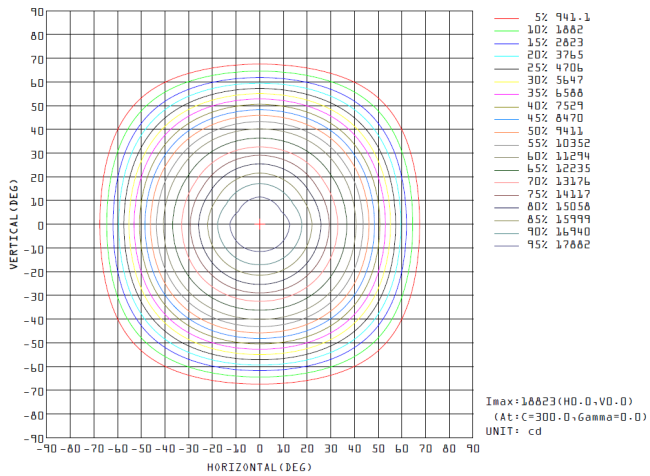
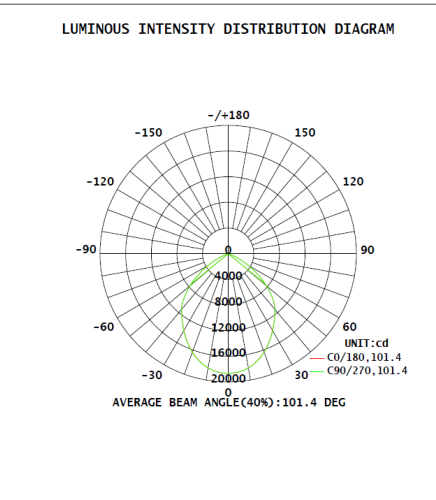
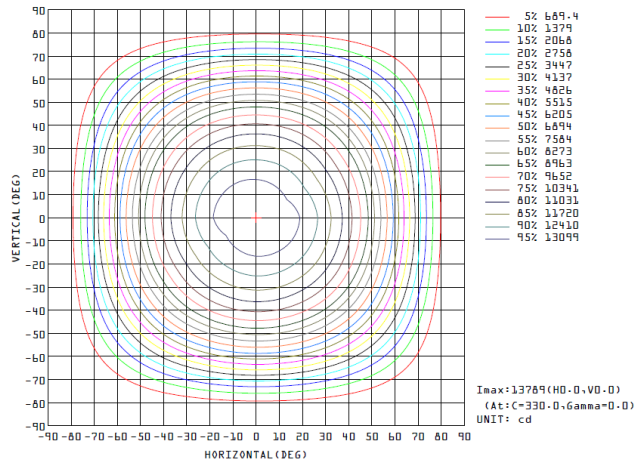
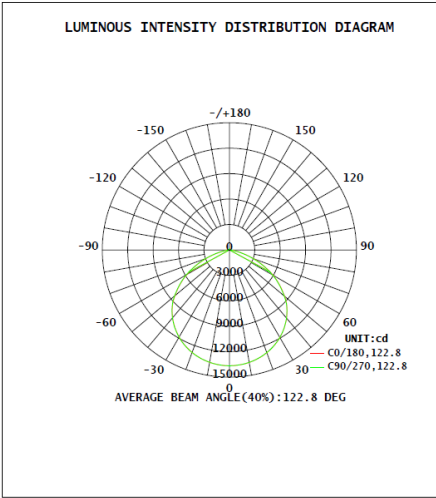

NORTH STAR
 LIGHTING