

Product # _____ Type _____ Date _____

Project Name _____

Project Location _____ Prepared By _____

Constellation 100W

100W LED Constellation Highbay

The 100 watt LED Constellation Highbay has been engineered to efficiently light any large interior space. It provides specification grade optical performance using high efficacy LED and high power factor LED drivers.

Construction

The LED Constellation Highbay has flexible modular design made out of aluminum alloy.

Optics/Lens

The 100 watt LED Constellation Highbay utilizes IP66 sealed light modules. Available in 90, 70x135, 30x100, 110, 150, and 60x100 degree beam pattern.

Electrical

Performance greater than 100 lumens per watt. Standard Color Temperature 5500K, CRI of 80 or greater. Other optional color temp and CRI available on request. LED Drivers: UL/CSA recognized component to meet UL8750 & EN61347 (USR/CNR -E328335). Suitable for input power at 100-277 VAC. Minimum power factor over 0.95 with an operating temperature range of -22F-113F (-30C-45C). Available dimming options include: PWM, 1-10V, Microwave sensor, or Infrared sensor.

Product Applications

The LED Constellation Highbay is designed to efficiently light any large interior space such as warehouses and manufacturing facilities, convention centers/sporting arenas, big-box retail stores, cold storage facilities and gymnasiums.

Warranty and Certifications

5 years for LED Light Engine and Driver 50,000 hours L70 LED Illumination per LM-80. cETLus wet locations in compliance with UL 1598 and CSA C22.2 NO. 250.0 standards. IP66 rated. Suitable for indoor/outdoor wet or damp location use. DLC listed.

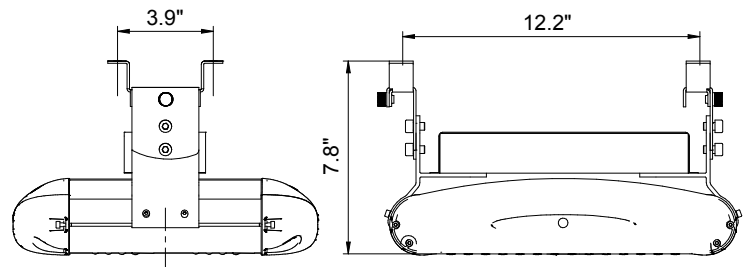

Weight: 11lbs / 5kg



Ordering Guide

MODEL	TOTAL LED POWER	SERIES	CCT COLOR TEMP	LIGHT BEAM SPREAD	INPUT VAC	LIGHTING CONTROL	MOUNTING OPTION
Con	100 = 100W	HB	2500-5500K* 4500-5500K Standard *+/-350K	90° 70x135° 30x100° 60x100° 110° 150°	U = Universal 120V to 277V 48 = 480V* *Consult factory for 48	ND = Non Dimming D = Dimming 1-10V PWM=PWM MS=Microwave Sensor IS=Infrared Sensor	SM- Surface Mount HK- Hook/Chain Mount HB-Universal Hanging Bracket

Note: Due to continued efforts to improve our products, specifications are subject to change without notice.



835 Industrial Drive, Elmhurst, IL 60126 708.681.4330 www.nslights.com

Constellation 100W

Photometrics

70x135 DEGREE LENS (Forward 5°)

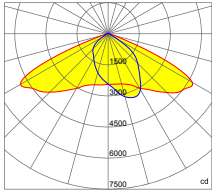

0.0~180.0
90.0~270.0

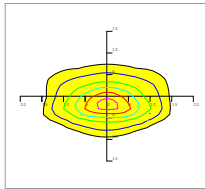

Mounting Height 7m, 0 Tilt,
50LUX-5LUX

Height	Rectangular Light Spot	LUX
5m	9x24m	90LUX
6m	11x29m	66LUX
7m	13x34m	50LUX
8m	14x39m	39LUX
9m	15x43m	31LUX

Beam Angle (50% max)	70x135 DEG
Field Angle (10%)	100x160 DEG
Luminous Flux (IES)	10,000 lm
Light Efficacy (IES)	100 lm/W
Cutoff Classification	Cutoff

30x100 DEGREE LENS

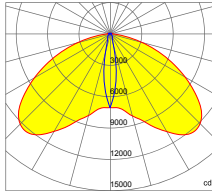

0.0~180.0
90.0~270.0

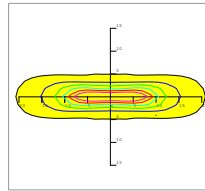

Mounting Height 10m, 0 Tilt,
50LUX-5LUX

Height	Rectangular Light Spot	LUX
6m	3x11m	231LUX
7m	3x13m	170LUX
8m	4x15m	131LUX
9m	4x17m	104LUX
10m	4x19m	84LUX

Beam Angle (50% max)	30x100 DEG
Field Angle (10%)	50x120 DEG
Luminous Flux (IES)	10,000 lm
Light Efficacy (IES)	>100 lm/W
UGR	13/39
Cutoff Classification	Semi-Cutoff

90 DEGREE LENS

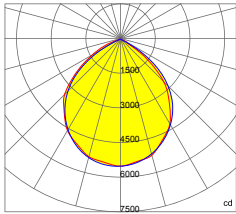

0.0~180.0
90.0~270.0

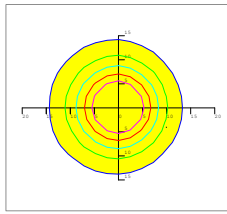

Mounting Height 12m, 0 Tilt,
50LUX-5LUX

Height	Beam Diameter	LUX
5m	φ 14m	132LUX
6m	φ 16m	99LUX
7m	φ 19m	76LUX
8m	φ 23m	58LUX
9m	φ 24m	46LUX

Beam Angle (50% max)	90 DEG
Field Angle (10%)	130 DEG
Luminous Flux (IES)	10,000 lm
Light Efficacy (IES)	100 lm/W
UGR	25
Cutoff Classification	Cutoff

110 DEGREE LENS

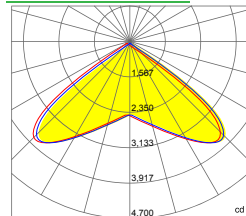

0.0~180.0
90.0~270.0

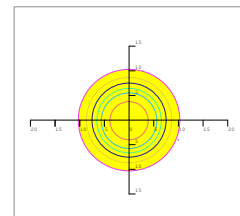

Mounting Height 10m, 0 Tilt,
50LUX-5LUX

Height	Rectangular Light Spot	LUX
2m	4.0x4.3m	595LUX
4m	8.0x8.6m	149LUX
6m	12.0x13.0m	66LUX
8m	15.9x17.3m	37LUX
10m	19.9x21.6m	24LUX

Beam Angle (50% max)	110 DEG
Luminous Flux (IES)	10,000 lm
Light Efficacy (IES)	100 lm/W
Cutoff Classification	Cutoff

150 DEGREE LENS

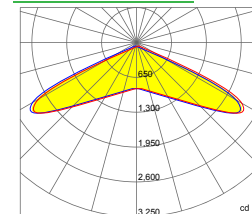

0.0~180.0
90.0~270.0

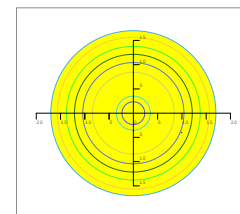

Mounting Height 10m, 0 Tilt,
50LUX-5LUX

Height	Rectangular Light Spot	LUX
2m	1.8x5.3m	303LUX
4m	3.7x10.7m	76LUX
6m	5.5x16.0m	34LUX
8m	7.4x21.4m	19LUX
10m	9.2x26.7m	12LUX

Beam Angle (50% max)	150 DEG
Luminous Flux (IES)	10,000 lm
Light Efficacy (IES)	100 lm/W
Cutoff Classification	Cutoff

60 x 100 DEGREE LENS

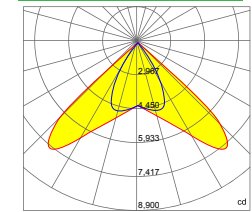

0.0~180.0
90.0~270.0

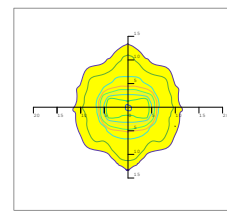

Mounting Height 10m, 0 Tilt,
50LUX-5LUX

Height	Rectangular Light Spot	LUX
2m	1.5x2.2m	986LUX
4m	2.9x4.4m	246LUX
6m	4.4x6.6m	110LUX
8m	5.8x8.7m	62LUX
10m	7.3x10.9m	40LUX

Beam Angle (50% max)	60x100 DEG
Luminous Flux (IES)	10,000 lm
Light Efficacy (IES)	100 lm/W
Cutoff Classification	Cutoff

Constellation 100W

Mounting Options

Hook/Chain Mount

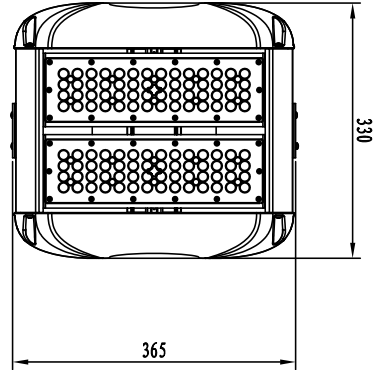
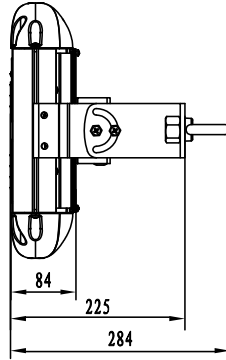

Universal Hanging Bracket

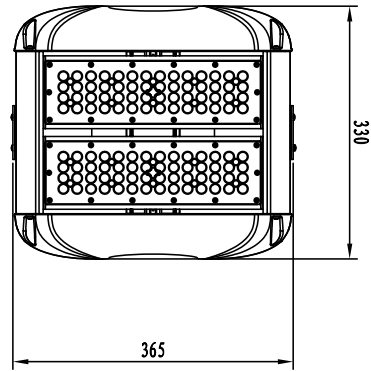
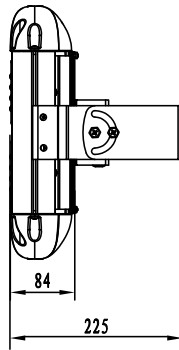

Surface Mount

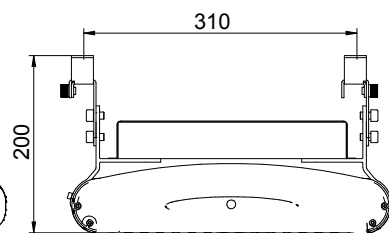
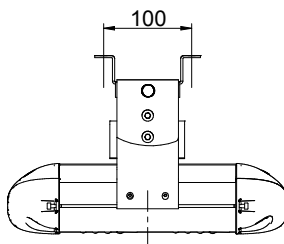
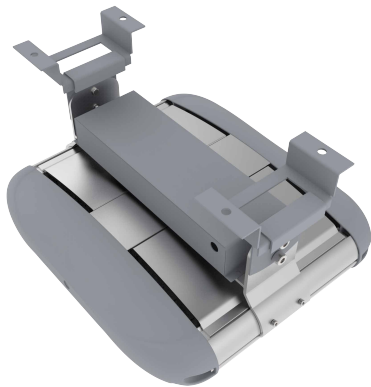

NORTHSTAR
LIGHTING

835 Industrial Drive, Elmhurst, IL 60126 708.681.4330 www.nslights.com